

Current Sense Transformer

ACSTE4.2 SERIES

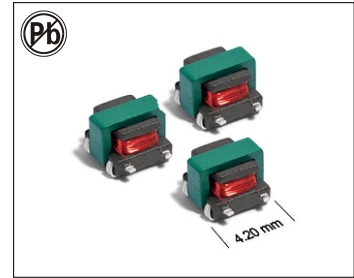

FEATURES:

- AEC-Q200 Grade 1 (40°C to +125°C)
- Miniature SMT design, only 4.5 × 4.8mm footprint
- 500Vrms, one minute isolation (hipot) between windings
- Designed for use up to 1MHz and above to sense continuous currents to 7 Amps

APPLICATIONS:

- Switching power supplies
- Feedback control
- Overload sensing
- Load drop/Shut down detection

ELECTRICAL SPECIFICATIONS:

| Part No. | Turns ratio | Ls (uH, Min) 100KHz, 0.1V | Rp (Ω, Max) | Rs (Ω, Max) | Sensed Current (A) | Frequency range (KHz) | Volt-time product (Vusec) | Rt (Ω) |
|--------------|-------------|---------------------------------|----------------|----------------|--------------------------|-----------------------------|---------------------------------|-----------|
| ACSTE4.2-200 | 1:20 | 33 | 0.003 | 0.35 | 7 | 83-1000 | 6 | 2.9 |
| ACSTE4.2-300 | 1:30 | 74 | 0.003 | 0.9 | 7 | 56-1000 | 9 | 4.3 |
| ACSTE4.2-400 | 1:40 | 132 | 0.003 | 1.6 | 7 | 42-1000 | 12 | 5.7 |
| ACSTE4.2-500 | 1:50 | 205 | 0.003 | 2.5 | 7 | 33-1000 | 15 | 7.1 |
| ACSTE4.2-600 | 1:60 | 295 | 0.003 | 3.6 | 7 | 28-1000 | 18 | 8.6 |
| ACSTE4.2-700 | 1:70 | 400 | 0.003 | 4.6 | 7 | 24-1000 | 21 | 10 |
| ACSTE4.2-101 | 1:100 | 820 | 0.003 | 9.5 | 7 | 17-1000 | 30 | 14.3 |
| ACSTE4.2-121 | 1:125 | 1280 | 0.003 | 13.0 | 7 | 13-1000 | 37.5 | 17.9 |
| ACSTE4.2-151 | 1:150 | 1800 | 0.003 | 21.0 | 7 | 11-1000 | 45 | 21.4 |

MECHANICAL:

Unit:mm

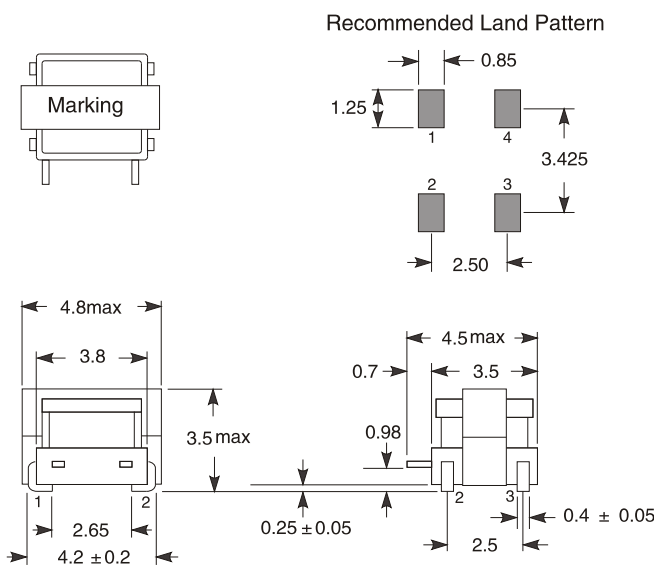

Schematic

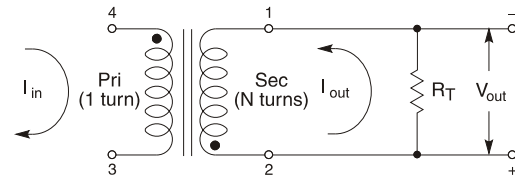

Temperature Rise vs Current

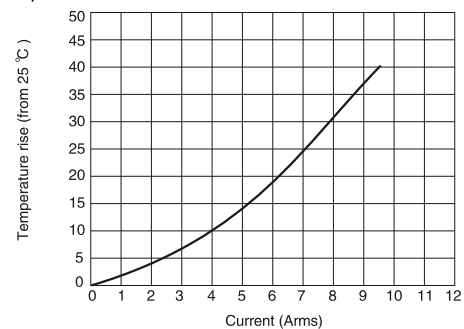

NOTES

- 1.Primary current of 7 A causes less than 25°C temperature rise from 25°C ambient. Higher current causes a greater temperature rise
- 2.Ambient temperature 40°C to +125°C
- 3.Maximum part temperature +165°C (ambient + temp rise)
- 4.Storage temperature Component: 40°C to +165°C
Tape and reel Packaging: 40°C to +80°C
- 5.Inductance measured between secondary pins at 100kHz, 0.1 Vrms, 0 Adc
- 6.Electrical specifications at 25°C
- 7.Inductance measured at 0Adc on HP 4284A LCR Meter or equivalent
- 8.DCR measured on Chroma 16502 micro-ohmmeter or equivalent

Specifications subject to change without notice

Current Sense Transformer

ACSTE4.6 SERIES

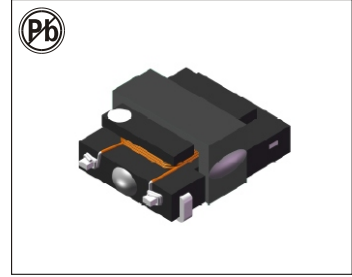

FEATURES:

- Very low DC resistance
- Different turns ratios
- Very small package
- 500Vrms,one minute isolation(hipot) between windings
- Sensed Current – primary rated for 20 Amps

APPLICATIONS:

- Switching power supplies
- Feedback control
- Overload sensing
- Load drop/Shut down detection

ELECTRICAL SPECIFICATIONS:

| Part No. | Turns ratio | Ls (uH, Min) 100KHz,0.1V | Rp (Ω,Max) | Rs (Ω,Max) | Sensed Current (A) |
|--------------|-------------|--------------------------|------------|------------|--------------------|
| ACSTE4.6-200 | 1:20 | 53 | 0.0015 | 0.42 | 9 |
| ACSTE4.6-500 | 1:50 | 333 | 0.0015 | 2.76 | 9 |
| ACSTE4.6-700 | 1:70 | 652 | 0.0015 | 5.04 | 9 |
| ACSTE4.6-101 | 1:100 | 1330 | 0.0015 | 10.68 | 9 |
| ACSTE4.6-151 | 1:150 | 2993 | 0.0015 | 22.30 | 9 |

MECHANICAL: Unit:mm

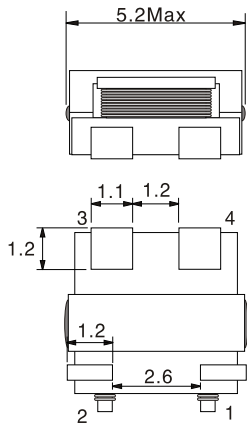

Bottom view

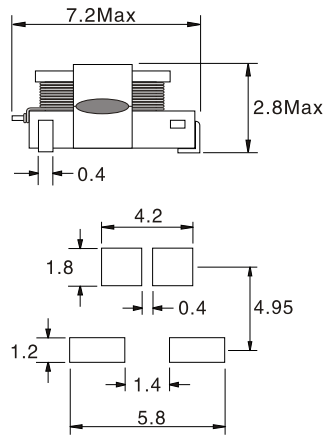

Recommended PCB layout

Schematic

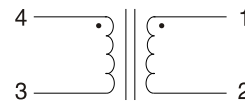

NOTES

- 1.Primary current of 9 A causes less than 35°C temperature rise from 25°C ambient. Higher current causes a greater temperature rise
- 2.Operating temperature : -40°C to 125°C
- 3.Storage temperature Component: -40°C to +125°C
- 4.Inductance measured between secondary pins at 100kHz, 0.1 Vrms, 0 Adc
- 5.Measuring Frequency: @50KHz to 1MHz
- 6.Electrical specifications at 25°C
- 7.Inductance measured at 0Adc on HP 4284A LCR Meter or equivalent
- 8.DCR measured on Chroma 16502 micro-ohmmeter or equivalent

Specifications subject to change without notice

Current Sense Transformer

ACSTE5.0 SERIES

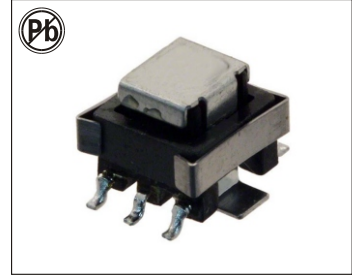

FEATURES:

- Very low DC resistance
- Different turns ratios
- Small package
- Other pinning on request

APPLICATIONS:

- Switching power supplies
- Feedback control
- Overload sensing
- Load drop/Shut down detection

ELECTRICAL SPECIFICATIONS:

| Part No. | Turns ratio | Ls (uH, Min) 100KHz, 0.1V | Rp (Ω, Max) | Rs (Ω, Max) | Sensed Current (A) |
|--------------|-------------|---------------------------------|----------------|----------------|-----------------------|
| ACSTE5.0-200 | 1:20 | 80 | 0.0007 | 0.4 | 10 |
| ACSTE5.0-300 | 1:30 | 180 | 0.0007 | 0.87 | 10 |
| ACSTE5.0-400 | 1:40 | 320 | 0.0007 | 1.14 | 10 |
| ACSTE5.0-500 | 1:50 | 500 | 0.0007 | 1.85 | 10 |
| ACSTE5.0-600 | 1:60 | 730 | 0.0007 | 2.3 | 10 |
| ACSTE5.0-700 | 1:70 | 980 | 0.0007 | 4.75 | 10 |
| ACSTE5.0-101 | 1:100 | 2000 | 0.0007 | 5.5 | 10 |
| ACSTE5.0-121 | 1:125 | 3000 | 0.0007 | 11.5 | 10 |

MECHANICAL: Unit:mm

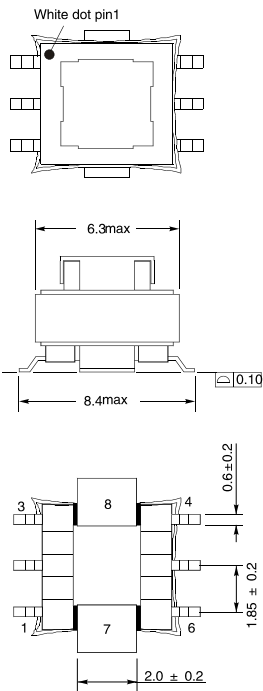

Schematic

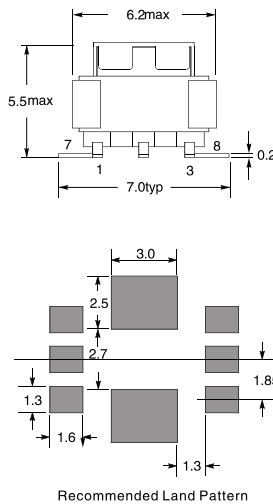
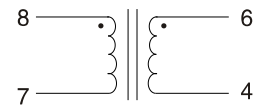

Recommended Land Pattern

NOTES

1. Operating temperature : -40°C to 125°C
2. Storage temperature Component: -40°C to +125°C
3. Inductance measured between secondary pins at 100kHz, 0.1 Vrms, 0 Adc
4. Electrical specifications at 25°C
5. Inductance measured at 0Adc on HP 4284A LCR Meter or equivalent
6. DCR measured on Chroma 16502 micro-ohmmeter or equivalent

Specifications subject to change without notice

SMT CURRENT SENSE TRANSFORMERS

ACSTEP7 SERIES

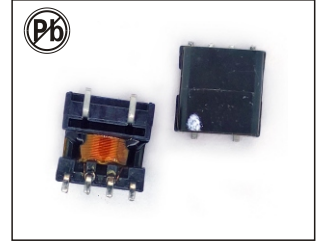

FEATURES:

- Very low DC resistance
- Different turns ratios
- Small SMD package
- RoHS compatible
- Insulation distances in compliance with IEC 60664

APPLCATIONS:

- Switch-mode power supplies
- Feedback control
- Overload sensing
- Load drop/shut-down detection

ELECTRICAL CHARACTERISTICS:

| Part Number | Turns | Inductance (mH) Min | Voltage-time product +120°C (V.us) (1) | Cp (pF) | R(1-2) (mΩ) Max | R(4-5) (Ω) Max | Rt ⁽²⁾ (Ω) Typ. |
|-------------|-------|---------------------|--|---------|-----------------|----------------|----------------------------|
| ACSTEP7-50 | 50 | 1.7 | 116 | 4 | 1.9 | 2.1 | 2.5 |
| ACSTEP7-70 | 70 | 3.0 | 163 | 4 | 1.9 | 2.9 | 3.5 |
| ACSTEP7-100 | 100 | 7.0 | 233 | 4 | 1.9 | 5.0 | 5.0 |
| ACSTEP7-125 | 125 | 11.0 | 291 | 4 | 1.9 | 5.3 | 6.0 |

Notes:

- (1)The maximum volt-second rating limits the peak flux density to 220 mT when used in a unipolar drive application.For bipolar drive applications, a maximum volt-sec of two times is acceptable.
- (2)Burden Resistor value is calculated by taking Vout as 1 V reference and with maximum input current (20 A)flowing through the primary winding of the current sense transformer

PHYSICAL CHARACTERISTICS & WINDING

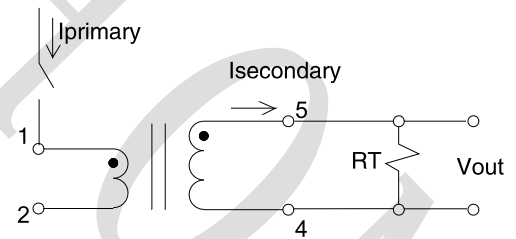
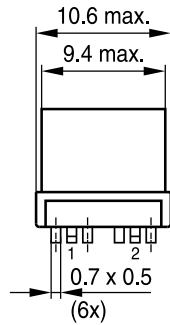
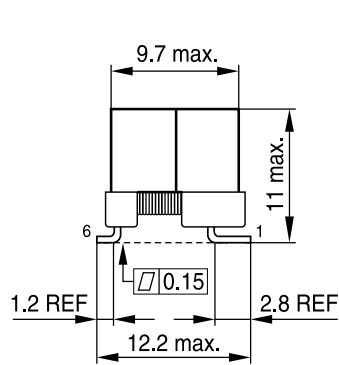

Recommended PCB layout (Top view)

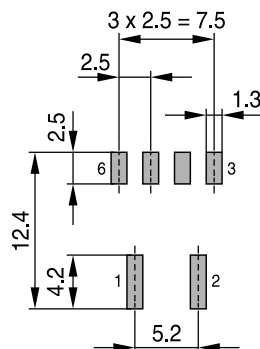
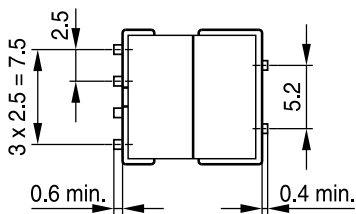

- Typical frequency range: 50~250KHz
- Inductance test frequency: 20KHz,0.01V
- High voltage test: 2400VAC,50Hz,1s (Coil to Coil)
- The max primary current of 20A causes approx +40°C temperature rise
- Couple capacitance measured at 10kHz, 1V, +25°C
- Operating temperature range -40°C to +150°C

Current Sense Transformer

ACSTE8.3 SERIES

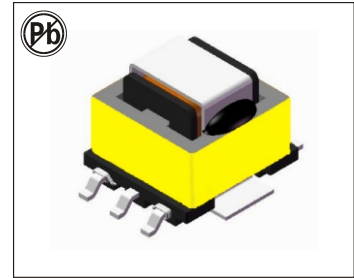

APPLICATIONS:

- Power supply for VTRs
- Small surface mount current sensors
- Sensed current up to 30A; Frequency range up to 1MHz
- Very low primary DC resistance
- 1.5KV AC/3mA / 1S isolation (hipot) between windings

ELECTRICAL SPECIFICATIONS:

| Part No. | Turns ratio | Ls (mH, Min) 100KHz, 0.1V | Rp (Ω, Max) | Rs (Ω, Max) | Sensed Current (A) |
|--------------|-------------|---------------------------------|----------------|----------------|-----------------------|
| ACSTE8.3-200 | 1:20 | 0.22 | 0.0039 | 0.21 | 30 |
| ACSTE8.3-300 | 1:30 | 0.5 | 0.0039 | 0.32 | 30 |
| ACSTE8.3-400 | 1:40 | 0.88 | 0.0039 | 0.50 | 30 |
| ACSTE8.3-500 | 1:50 | 1.4 | 0.0039 | 0.65 | 30 |
| ACSTE8.3-600 | 1:60 | 2.0 | 0.0039 | 0.81 | 30 |
| ACSTE8.3-700 | 1:70 | 2.7 | 0.0039 | 1.0 | 30 |
| ACSTE8.3-800 | 1:80 | 3.5 | 0.0039 | 1.3 | 30 |
| ACSTE8.3-101 | 1:100 | 5.6 | 0.0039 | 2.0 | 30 |
| ACSTE8.3-121 | 1:125 | 8.7 | 0.0039 | 5.2 | 30 |
| ACSTE8.3-151 | 1:150 | 12.6 | 0.0039 | 6.5 | 30 |
| ACSTE8.3-201 | 1:200 | 22.0 | 0.0039 | 8.0 | 30 |

MECHANICAL: Unit:mm

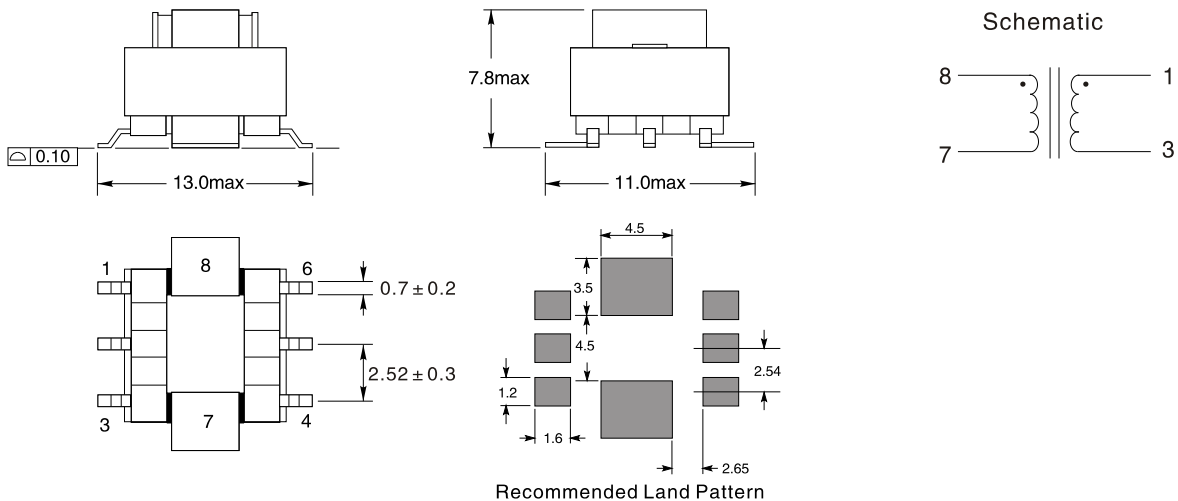

NOTES

- 1.High Current – primary rated for 30 Amps
- 2.Operating temperature : -40°C to 125°C
- 3.Storage temperature Component: -40°C to +125°C
- 4.Inductance measured between secondary pins at 100kHz, 0.1 Vrms, 0 Adc
- 5.Operating Frequency Range up to 100KHz
- 6.Electrical specifications at 25°C
- 7.Inductance measured at 0Adc on HP 4284A LCR Meter or equivalent
- 8.DCR measured on Chroma 16502 micro-ohmmeter or equivalent

Specifications subject to change without notice

SMT CURRENT SENSE TRANSFORMERS ACSTE12 SERIES

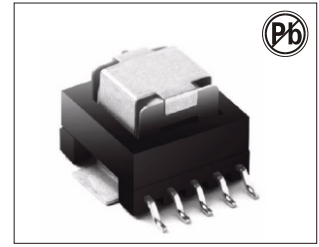

FEATURES:

- Height: 10mm Max
- Footprint: 19.9mm X 15.0mm Max
- Frequency range: 50KHz to 500KHz
- Current rating: up to 40A
- Operating temperature: -40°C to +130°C

ELECTRICAL CHARACTERISTICS:

| Part Number | Turns ratio | Sec. Inductance (mH) 10KHz,0.1V | DCR | | Hi-Pot (Vrms) |
|-------------|-------------|------------------------------------|-------------|------------|---------------|
| | | | Pri (mΩ)Max | Sec (Ω)Max | |
| ACSTE12-200 | 1:20 | 0.34min. | 0.36 | 0.18 | 500 |
| ACSTE12-300 | 1:30 | 0.76min. | 0.36 | 0.265 | 500 |
| ACSTE12-400 | 1:40 | 1.36min. | 0.36 | 0.56 | 500 |
| ACSTE12-500 | 1:50 | 2.12min. | 0.36 | 0.705 | 500 |
| ACSTE12-600 | 1:60 | 3.06min. | 0.36 | 0.85 | 500 |
| ACSTE12-700 | 1:70 | 4.16min. | 0.36 | 1.0 | 500 |
| ACSTE12-800 | 1:80 | 5.44min. | 0.36 | 1.15 | 500 |
| ACSTE12-101 | 1:100 | 8.50min. | 0.36 | 1.45 | 500 |
| ACSTE12-121 | 1:125 | 13.3min. | 0.36 | 1.85 | 500 |
| ACSTE12-151 | 1:150 | 19.2min. | 0.36 | 2.25 | 500 |
| ACSTE12-201 | 1:200 | 34.0min. | 0.36 | 4.06 | 500 |

1. The temperature of component (ambient temperature plus temperature rise) must be within the specified operating temperature range.
2. The maximum current rating is based upon temperature rise of the component and represents the DC current which will cause a typical temperature rise of 40°C with no airflow when both one turn windings connected in parallel.

PHYSICAL CHARACTERISTICS & WINDING

Dimension: mm

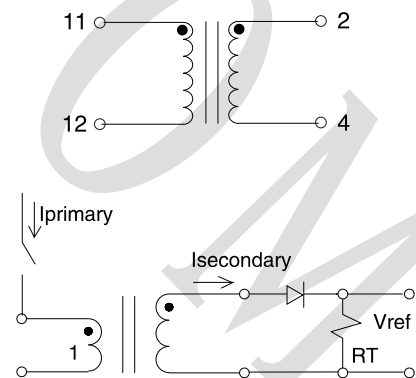
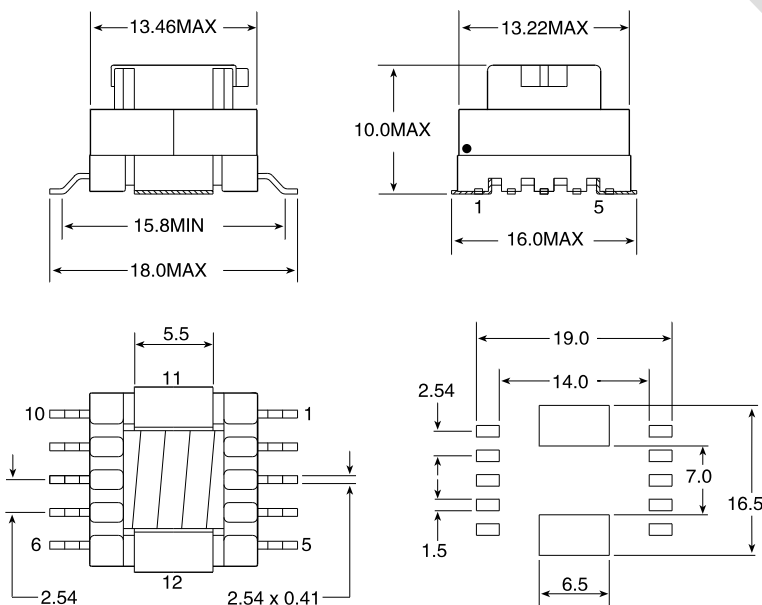

APPLICATION CIRCUIT

Weight..... 4.7g
Tray..... 100/tray
Tape&Reel..... 300/reel

Unless otherwise specified, all tolerances are ± 0.25mm

SMT CURRENT SENSE TRANSFORMERS

ACSTE25 SERIES

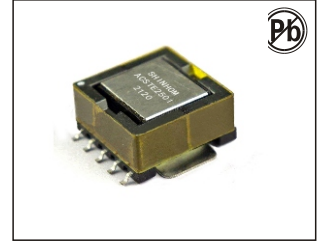

FEATURES:

- Very low DC resistance
- Different turns ratios
- Very small package
- 1500Vrms isolation voltage between windings
- Sensed Current – primary rated for 50 Amps

APPLICATIONS:

- Switching power supplies
- Feedback control
- Overload sensing
- Load drop/Shut down detection

ELECTRICAL CHARACTERISTICS: @25°C

| Part Number | Turns ratio | Sec. Inductance (mH) 100KHz,0.1V | DCR (mΩ)Max | | Rated input current (A) Max |
|-------------|-------------|-------------------------------------|-------------|------|-----------------------------|
| | | | Pri | Sec | |
| ACSTE2501 | 1:100 | 15.0 min. | 0.2 | 1200 | 50 |
| ACSTE2502 | 1:150 | 34.0 min. | 0.2 | 1600 | 50 |
| ACSTE2503 | 1:200 | 60.0 min. | 0.2 | 2000 | 50 |

PHYSICAL CHARACTERISTICS & WINDING

Dimension: mm

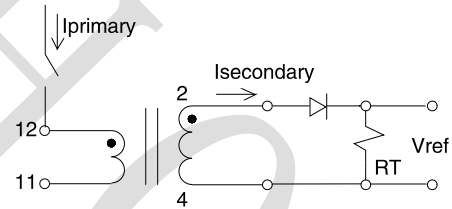
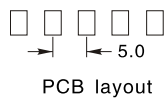
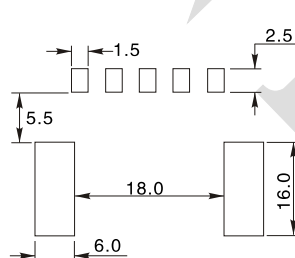
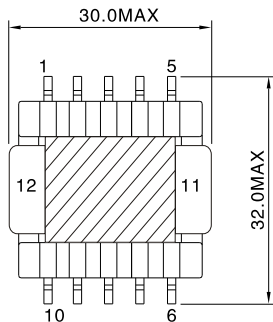
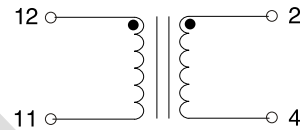
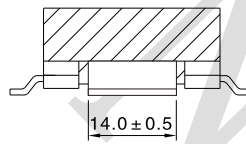
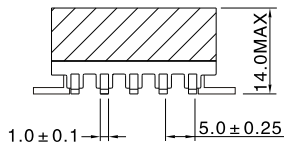

APPLICATION CIRCUIT

NOTES

- 1.Primary current of 50 A causes 40°C temperature rise from 25°C ambient. Higher current causes a greater temperature rise
- 2.Operating temperature : -55°C to 125°C
- 3.Storage temperature Component: -40°C to +105°C
- 4.Tape and reel packaging: -40°C to +80°C
- 5.Moisture sensitivity level(MSL) 1 (Unlimited floor life at <30deg /85% relative humidity)
- 6.Inductance measured between secondary pins at 100kHz, 0.1 Vrms, 0 Adc
- 7.Frequency range: 50KHz to 500KHz
- 8.Inductance measured at 0Adc on HP 4284A LCR Meter or equivalent
- 9.DCR measured on Chroma 16502 micro-ohmmeter or equivalent

Specifications subject to change without notice

SHINHOM ELECTRONICS ENTERPRISE CO.,LTD. No.8,YanTa Northern Road Zip:710054 Tel:0086-29-87851838 Fax:0086-29-87851840

SMD CURRENT SENSER TRANSFORMERS

ACSTE50 Series

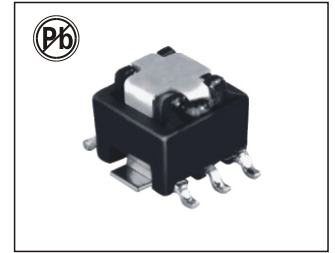

FEATURES:

- Working Frequency range:50KHz~1MHz
- Testing Frequency: 10 KHz 0.1Vrms
- Hipot:2000VAC,Primary to Secondary
- Maximum Sensing Current: 20A
- All secondary measurements are in pins 1-3
- Soldering methods: Wave, Reflow

Electrical Specifications @ 25°C — Operating Temperature -40°C to +130°C

| Part No. | Turns Ratio | Current Rating (A) | Secondary inductance (mH)Min | DCR(mΩ Max) | | Hi-Pot (Vrms) |
|-----------|-------------|--------------------|------------------------------|---------------|-----------------|---------------|
| | | | | Primary (8-7) | Secondary (1-3) | |
| ACSTE5020 | 1:20 | 20 | 0.08 | 0.75 | 550 | 500 |
| ACSTE5030 | 1:30 | 20 | 0.18 | 0.75 | 870 | 500 |
| ACSTE5040 | 1:40 | 20 | 0.32 | 0.75 | 1140 | 500 |
| ACSTE5050 | 1:50 | 20 | 0.50 | 0.75 | 1500 | 500 |
| ACSTE5060 | 1:60 | 20 | 0.72 | 0.75 | 2250 | 500 |
| ACSTE5070 | 1:70 | 20 | 0.98 | 0.75 | 4750 | 500 |
| ACSTE5100 | 1:100 | 20 | 2.00 | 0.75 | 5500 | 500 |
| ACSTE5125 | 1:125 | 20 | 3.00 | 0.75 | 6500 | 500 |

MECHANICAL:

SCHEMATIC:

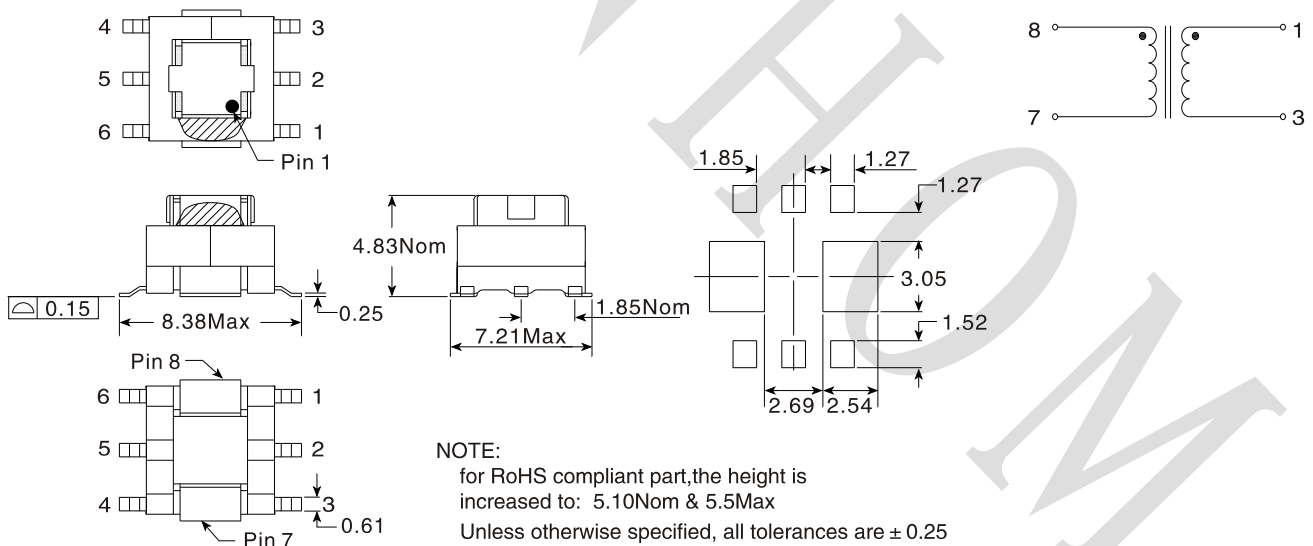

NOTES:

1. The temperature of component (ambient temperature plus temperature rise) must be within the specified operating temperature range.
2. The maximum current rating is based upon temperature rise of the component and represents the DC current which will cause a typical temperature rise of 40°C with no airflow when both one turn windings connected in parallel.
3. To calculate value of terminating resistor (Rt) use the following formula: $R_t (\Omega) = V_{ref} * N / (I_{peak_primary})$
4. The peak flux density of the device must remain below 2000 Gauss. To calculate the peak flux density for uni-polar current use following formula: $B_{pk} = 37.59 * V_{ref} * (Duty_Cycle_Max) * 105 / (N * Freq_kHz)$ * for bi-polar current applications divide Bpk (as calculated above) by 2

Current Sense Transformer

CT02 SERIES



FEATURES:

- Smallest Footprint
- Hi-Pot tested at 1500VAC
- Current ratings to 18A
- Patent pending

APPLICATION:

- DC/DC Converters
- DC/DC Converters
- POL Converters

ELECTRICAL SPECIFICATIONS :

| Part No. | Turns ratio | E-T Product (V-us) | Ls (mH, Min) | Rs (Ω, Max) | Current rating (A) | Hi-Pot (Vac) |
|----------|-------------|--------------------|--------------|-------------|--------------------|--------------|
| CT02-050 | 1:50 | 4.0 | 0.44 | 1.25 | 15.0 | 1500 |
| CT02-100 | 1:100 | 8.0 | 1.8 | 4.8 | 18.0 | 1500 |
| CT02-150 | 1:150 | 12.0 | 4.0 | 15.0 | 18.0 | 1500 |
| CT02-200 | 1:200 | 16.0 | 7.1 | 25.0 | 18.0 | 1500 |
| CT02-250 | 1:250 | 20.0 | 11.1 | 37.2 | 18.0 | 1500 |

Note: 1. K= ± 10%, M= ± 20%

MECHANICAL: Unit:mm

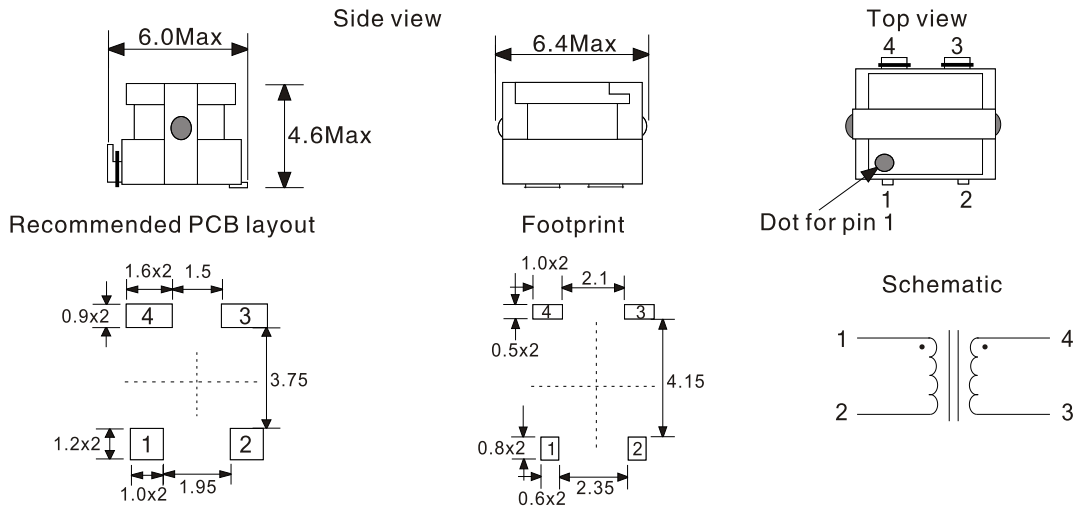

NOTES

1. Tested at 10kHz, 0.1Vrms.
2. Electrical specifications at 25°C
3. Operating range: -40 °C to +130 °C. This is a combination of ambient plus temperature rise.
4. Meets UL94V-0.
5. DC current through primary, plus turns-ratio-divided DC current through secondary winding, to cause a 40°C temperature rise at 25°C ambient.
6. All products are RoHS-compliant

Specifications subject to change without notice

SMT CURRENT SENSE TRANSFORMERS

ACSTEP11 SERIES

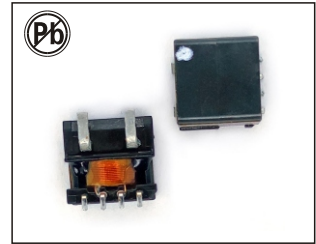

FEATURES:

- Very low DC resistance
- Different turns ratios
- Small SMD package
- RoHS compatible
- Qualified to AEC-Q200
- Insulation distances in compliance with IEC61558-2-16

APPLCATIONS:

- Switch-mode power supplies
- Feedback control
- Overload sensing
- Load drop/shut-down detection
- Switching current detection in on-board DC/DC converter and chargers

ELECTRICAL CHARACTERISTICS:

| Part Number | Turns ratio | Inductance (mH) 20KHz,0.01V | Voltage-time product +120°C (V.us) (1) | Cp (pF) 10KHz,1V | R(1-2) (mΩ) Max | R(4-5) (Ω) Max | Rt (2) (Ω) Typ. |
|---|-------------|--------------------------------|--|---------------------|-----------------|----------------|-----------------|
| ACSTEP11-50 | 1:50 | 1.2 Min | 117 | 4 | 0.5 | 1.5 | 1.6 |
| ACSTEP11-70 | 1:70 | 2.8 Min | 164 | 4 | 0.5 | 2.1 | 2.3 |
| ACSTEP11-100 | 1:100 | 6.5 Min | 235 | 4 | 0.5 | 3.1 | 3.3 |
| ACSTEP11-125 | 1:125 | 7.5 Min | 294 | 4 | 0.5 | 4.1 | 4.1 |
| ACSTEP11-180 | 1:180 | 18.0 Min | 423 | 4 | 0.5 | 7.4 | 6.0 |
| Small air gap ensures tighter tolerance of inductance for better sensing accuracy | | | | | | | |
| ACSTEP11-100A | 1:100 | 2.5 ± 12% | 235 | 4 | 0.5 | 3.1 | 3.3 |

Notes:

- (1)The maximum volt-second rating limits the peak flux density to 220 mT when used in an unipolar drive application. For bipolar drive applications, a maximum volt-sec of two times is acceptable.
- (2)Burden Resistor value is calculated by taking Vout as 1 V reference and with maximum input current flowing through the input (30 A).

PHYSICAL CHARACTERISTICS & WINDING

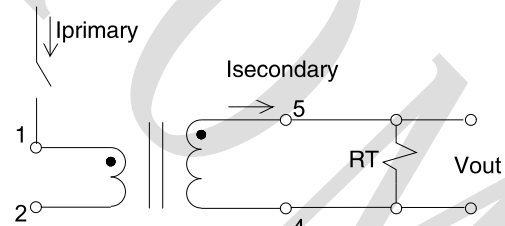
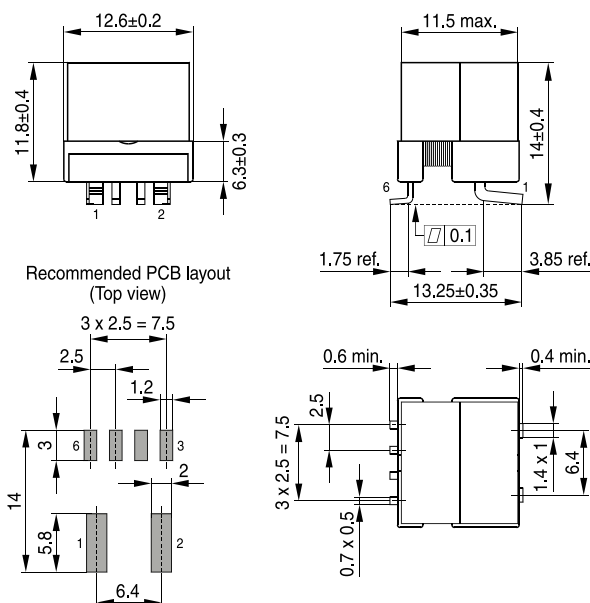

- Typical frequency range: 50~400KHz
- Inductance test frequency: 20KHz,0.01V
- High voltage test: 2500VAC,50Hz,1s (Pri to Sec, Core)
- The primary current of 30A causes approx +40°C temperature rise
- Couple capacitance measured at 10kHz, 1V, +25°C
- Operating temperature range -40°C to +150°C

INDUCTANCE L AS A FUNCTION OF TEMPERATURE TYPICAL CURVES

Parts without air gap according N(4-5) L/Lo vs. Temperature

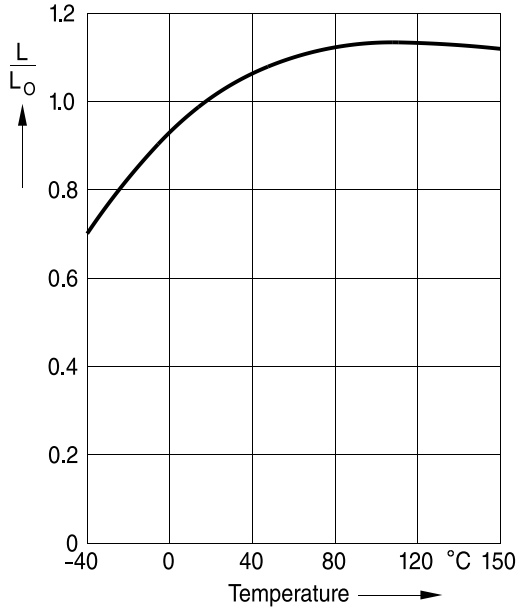

Parts with air gap according N(4-5) L/Lo vs. Temperature

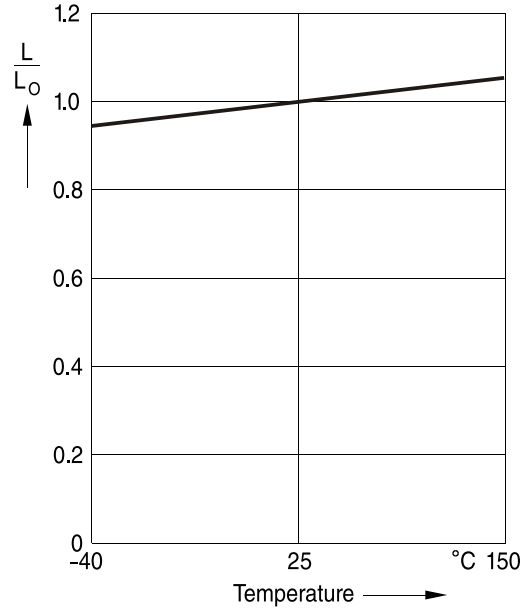

TAPING AND PACKING

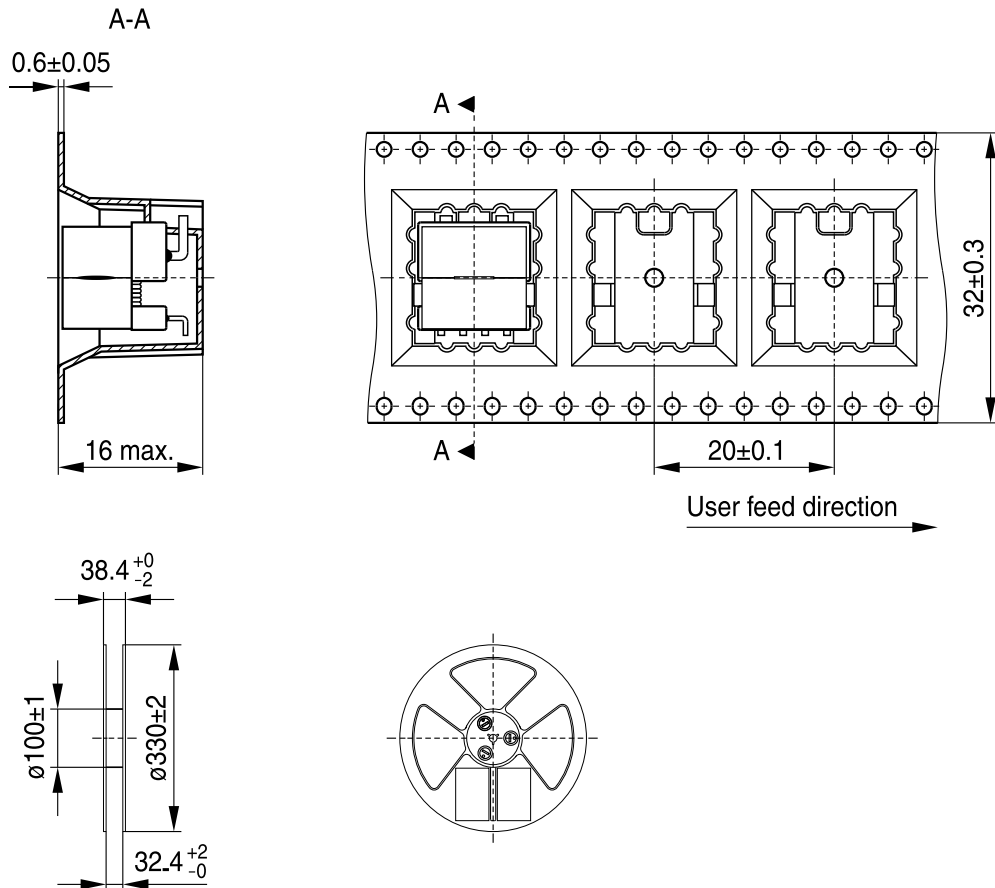

SMT CURRENT SENSE TRANSFORMERS

ACSTE11 SERIES

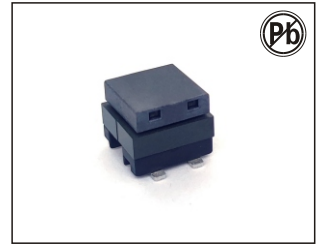

FEATURES:

- Height: 10mm Max
- Footprint: 12.5mm X 11.5mm Max
- Frequency range: 50KHz to 500KHz
- Primary rated current: 30A
- Operating temperature: -40°C to +125°C

ELECTRICAL CHARACTERISTICS:

| Part Number | Turns ratio | Sec. Inductance (mH) 10KHz,0.1V | DCR | | Hi-Pot (Vrms) |
|-------------|-------------|------------------------------------|-------------|------------|---------------|
| | | | Pri (mΩ)Max | Sec (Ω)Max | |
| ACSTE11-200 | 1:20 | 0.27min. | 0.8 | 0.36 | 500 |
| ACSTE11-300 | 1:30 | 0.61min. | 0.8 | 0.53 | 500 |
| ACSTE11-400 | 1:40 | 1.08min. | 0.8 | 1.12 | 500 |
| ACSTE11-500 | 1:50 | 1.68min. | 0.8 | 1.41 | 500 |
| ACSTE11-600 | 1:60 | 2.43min. | 0.8 | 1.70 | 500 |
| ACSTE11-700 | 1:70 | 3.30min. | 0.8 | 2.00 | 500 |
| ACSTE11-800 | 1:80 | 4.32min. | 0.8 | 2.30 | 500 |
| ACSTE11-101 | 1:100 | 6.75min. | 0.8 | 2.90 | 500 |
| ACSTE11-121 | 1:125 | 10.5min. | 0.8 | 3.70 | 500 |
| ACSTE11-151 | 1:150 | 15.2min. | 0.8 | 4.50 | 500 |
| ACSTE11-201 | 1:200 | 27.0min. | 0.8 | 8.10 | 500 |

1. The temperature of component (ambient temperature plus temperature rise) must be within the specified operating temperature range.
2. The maximum current rating is based upon temperature rise of the component and represents the DC current which will cause a typical temperature rise of 40°C with no airflow when both one turn windings connected in parallel.

PHYSICAL CHARACTERISTICS & WINDING

Dimension: mm

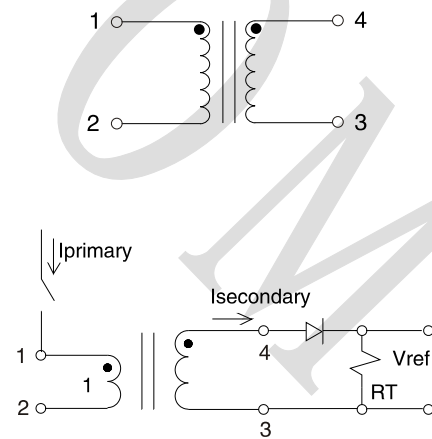
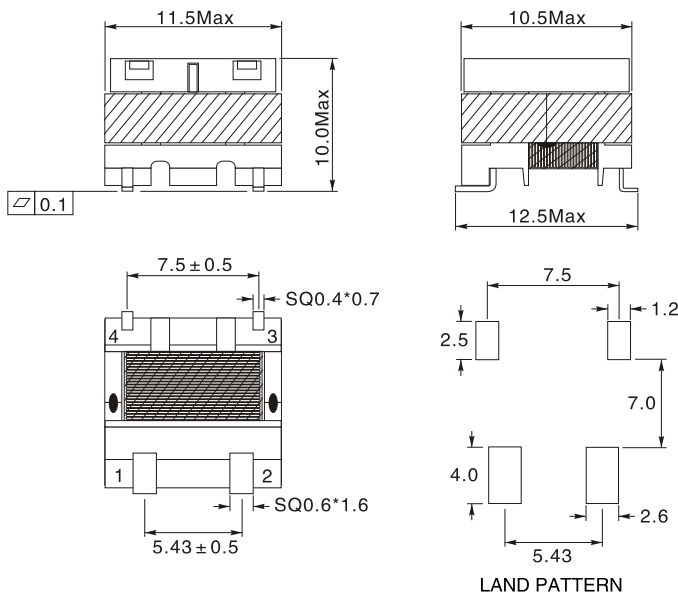

APPLICATION CIRCUIT

Unless otherwise specified, all tolerances are ± 0.25mm